

BPW turntables with double ball race

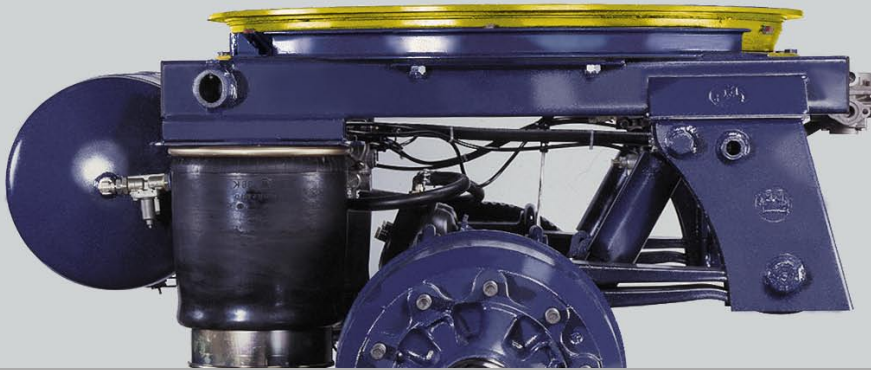

BPW turntables with double ball race

The no. 1 in system comparison

Compared to conventional, single-row systems, BPW turntables are characterized by the high-quality feature of a double ball race to guarantee optimum distribution of the axial and radial forces that arise.

The design superiority of this system that has proven itself in years of application is demonstrated in everyday use of drawbar trailers, semi-trailers, heavy transporters and special vehicles.

BPW turntables are used in particular when the vehicle construction places the most exacting requirements on design and material.

Optimum force transmission

BPW turntables have one axial and one radial ball race between the upper and lower rings.

- The vertical loads acting on the turntable are absorbed by the larger axial ball race.
- The horizontal forces are absorbed by the smaller radial ball race.
- The torque loadings arising from braking and centrifugal force are absorbed in the interplay between the two ball races.
- The radial ball race retains the upper and lower rings in place.

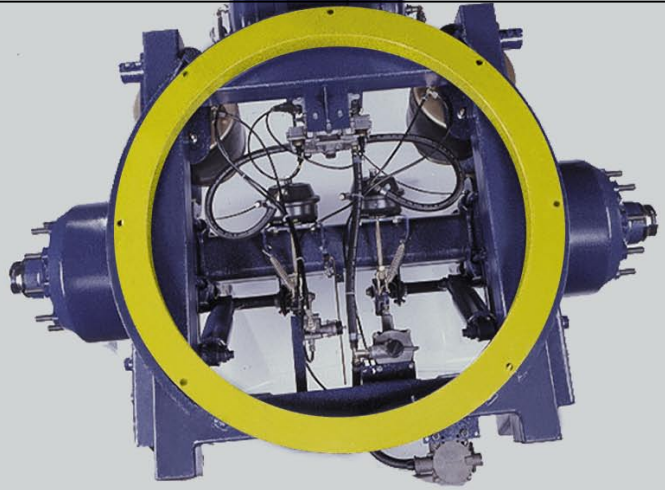

Absolute functional reliability

- The design principle guarantees the greatest possible safety, because the acting axial and radial forces are transmitted onto the two ball races separately.
- The special selection of material and production processes achieves the highest quality. The turntable sections made from high-strength steel are hot formed, butt welded and then heat treated at normalization temperature, thereby ensuring they have low levels of stress and can be used even under extreme conditions.

Economy through long service life

BPW turntables guarantee a minimum of downtime due to their long service life.

- The ball race is secured under load by the axial ball race.
- The space inside the turntable is provided with long-lasting protection against dust and dirt by a labyrinth seal.
- The sum of all these advantages ensures reliability, freedom of movement and the highest possible service life.

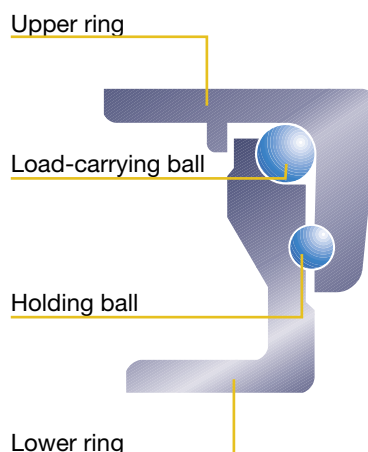

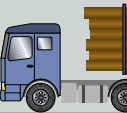

BPW turntables in use

Design and installation notes

■ The permitted axial load (see table) is the static vertical load acting on the turntable. It only applies for vehicles with a speed up to 105 km/h. A 25% higher axial load is permitted for vehicles with a speed up to 30 km/h. The BPW code number, production data, turntable type and permitted axial load are punched into the rating plate.

■ The support structure for the lower and upper rings must be smooth, level and torsionally rigid, otherwise deformation can be expected during operation and operational safety might thereby be impaired. Unevenness of the contact surfaces is not allowed to exceed 1 mm. Unevenness values greater than this must be corrected. The contact surface, divided into at least 4 equally sized surface portions evenly distributed around the circumference, must support at least 50% of the turntable flanges.

■ The turntable flanges must additionally be secured against movement at the top and bottom following bolting, using at least 4 weld-on plates (shear blocks) each. This means that the radial forces occurring do not have to be absorbed exclusively by the connection bolts.

■ We recommend using drilled turntables. No drilling chips or coolant is allowed to penetrate the ball races if drilling work is carried out subsequently.

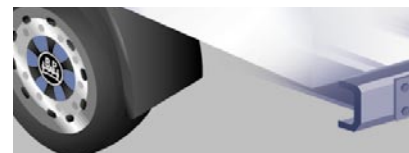

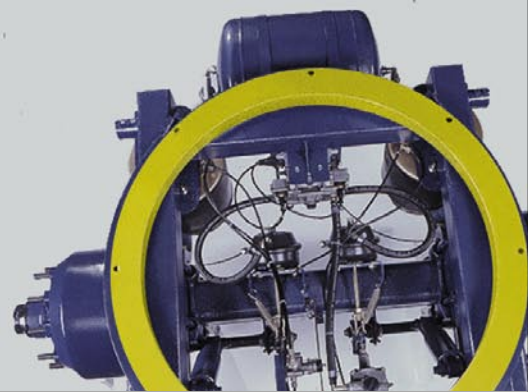
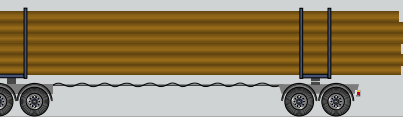

Maintenance

■ Turntables must be filled with BPW special long-life grease ECO-Li 91 (lithium complex grease) prior to operation, filling via the grease nipples. They are only lightly greased when new, which means the lubrication is only sufficient for emergency running.

■ BPW turntables are not suitable for applications involving repeated rotations of more than 360°.

■ BPW turntables are not suitable for off-centre loads.

■ Special applications require consultation with us.

■ Every 25,000 kilometres or at least quarterly (every 2-3 weeks under extreme application conditions), lubricate the turntable bearing with BPW special long-life grease ECO-Li 91 via the grease nipples (lithium complex grease).

The grease must not be mixed with different types of grease (calcium or sodium-saponified).

■ Regularly check all screw connections and tighten if necessary.

■ No welding work is allowed to be performed on BPW turntables, i.e. no parts are allowed to be welded on. When welding work is performed on the vehicle, the earth cable must be attached so as to ensure no current can flow through the turntable, otherwise the balls and races may be damaged.

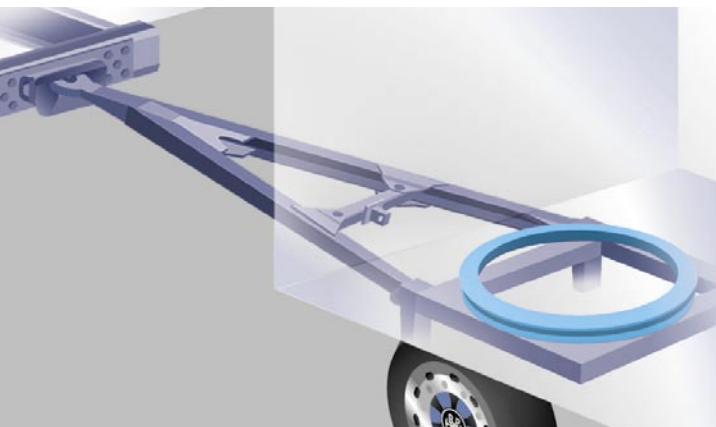

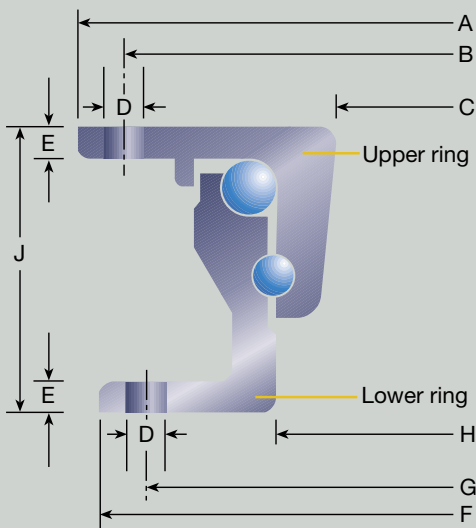

8-hole
DK 80/8

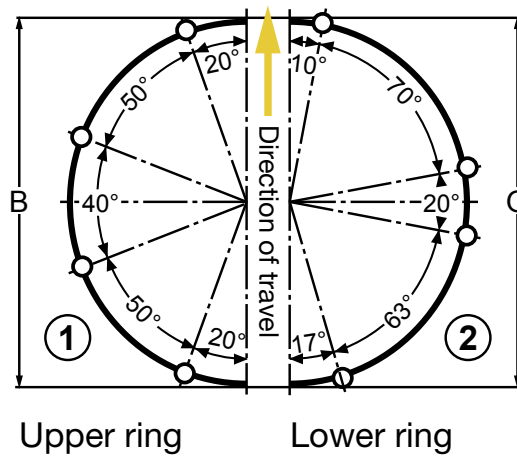

8-hole

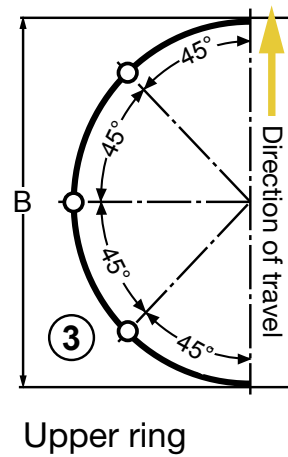

BPW standard delivery range

BPW turntables - drilled ²⁾		BPW turntable - undrilled				
Model	BPW code number	Model	BPW code number	Permitted axial load in t ⁴⁾	Permitted total trailer External Ø	
		DK 80/5	02.6415.01.00	5	25	664
DK 80/8	02.6415.10.00	DK 80/8	02.6415.11.00	8	40	894
DK 80/10	02.6415.13.00	DK 80/10	02.6415.14.00	10	50	1108
DK 80/16 A ³⁾	02.6415.17.00 ³⁾	DK 80/16 A ³⁾	02.6415.18.00 ³⁾	16	50	894
DK 90/10/1208	02.6415.66.00			10	50	1208
DK 90/10/1212	02.6415.70.00	DK 90/10/1200	02.6415.71.00	10	50	1208
DK 90/12	02.6415.24.00	DK 90/12	02.6415.23.00	12	50	1000
DK 90/13	02.6415.20.00	DK 90/13	02.6415.22.00	13	55	1108
DK 90/13/1208	02.6415.67.00			13	55	1208
DK 90/13/1212	02.6415.72.00	DK 90/13/1200	02.6415.73.00	13	55	1208
DK 90/14	02.6415.34.00	DK 90/14	02.6415.33.00	14	55	1000
DK 90/16	02.6415.30.00	DK 90/16	02.6415.31.00	16	60	1108
DK 90/16/1212	02.6415.74.00	DK 90/16/1200	02.6415.75.00	16	60	1208
DK 90/20	02.6415.41.00	DK 90/20	02.6415.40.00	20	60	1108
DK 90/20/1212	02.6415.76.00	DK 90/20/1200	02.6415.77.00	20	60	1208
DK 90/26/1212	02.6415.78.00	DK 90/26/1200	02.6415.79.00	26	70	1208
DK 90/30/1212 SP	02.6415.80.00	DK90/30/1200SP	02.6415.81.00	30	70	1208

10-hole
DK 80/16A

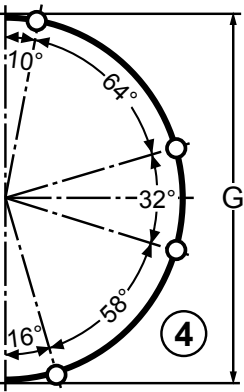

Lower ring

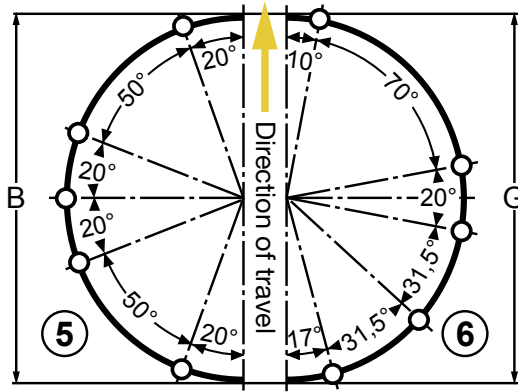

Upper ring

Lower ring

12-hole

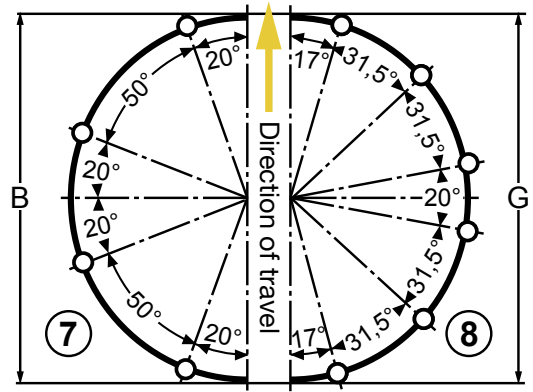

Upper ring

Lower ring

Upper ring						Lower ring						Bolt Per ring				
Part weight t	A mm	Pitch circle Ø B mm	Hole pattern	Internal Ø C mm	Hole Ø D mm	Flange thickness E mm	External Ø F mm	Pitch circle Ø G mm	Hole pattern	Internal Ø H mm	Hole Ø D mm	Flange thickness E mm	Quantity	Thread Ø min.	Design height J min.	Weight (kg)
(636)		519,5	(14)	9	650	(622)		554	(14)	9	8	(M 12)	80	38		
866	①	749,5	16	9	880	852	②	784	16	9	8	M 14	80	49		
1074	③	959,5	16	9	1095	1060	④	994	16	9	8	M 14	80	64		
866	⑤	749,5	16	9	880	852	⑥	784	16	9	10	M 14	80	49		
1174	③	1042,0	18	10	1195	1160	④	1079	18	10	8	M 16	90	92		
1174	⑦	1042,0	18	10	1195	1160	⑧	1079	18	10	12	M 16	90	92		
966	③	834,0	18	10	987	952	④	871	18	10	8	M 16	90	72		
1074	③	942,0	18	10	1095	1060	④	979	18	10	8	M 16	90	82		
1174	③	1042,0	18	10	1195	1160	④	1079	18	10	8	M 16	90	92		
1174	⑦	1042,0	18	10	1195	1160	⑧	1079	18	10	12	M 16	90	92		
966	③	834,0	18	10	987	952	④	871	18	10	8	M 16	90	72		
1074	③	942,0	18	10	1095	1060	④	979	18	10	8	M 16	90	82		
1174	⑦	1042,0	18	10	1195	1060	⑧	1079	18	10	12	M 16	90	95		
1074	③	942,0	18	10	1095	1060	④	979	18	10	8	M 16	90	82		
1174	⑦	1042,0	18	10	1195	1160	⑧	1079	18	10	12	M 16	90	95		
1174	⑦	1042,0	18	10	1195	1160	⑧	1079	18	10	12	M 16	90	96		
1174	⑦	1042,0	18	10	1195	1160	⑧	1079	18	10	12	M 16	90	96		

axial load = static axial load over the steered axle which acts on the turntable. Subject to modifications!



Corporate-Art · BPW-Turntables-07/1e

